



# Magellan All-in-one Wireless Security System

MG6250 Console

Version 1.6

## Menu Programming Guide





## Introduction

The MG6250 All-in-one Wireless Console is a two-partition, 64-zone wireless console, offering the latest in communication technology (reporting via GPRS, GSM, SMS, voice, and traditional landline). In addition, the MG6250 is enhanced with intuitive menu-driven programming capabilities. As a result, the MG6250 enables easy, fast, and efficient programming.

## Menu vs. Section-based Programming

The MG6250 can be programmed using either the menu-based approach (preferred method) described in this manual, via the section-based method, or a combination of both. Although relevant section-based information appears throughout this manual, refer to the MG6250 Section Programming Guide for complete details on the section-based programming method. Log-on to [paradox.com](http://paradox.com) to download the latest release of the MG6250 Section Programming Guide.

## Description of Menu Keys

- **ok**: Press to access menus and confirm actions
- **next**: Press to advance to next screen or menu
- **back**: Press to go back to previous screen

## Initial Power-up

1. Plug in your unit.

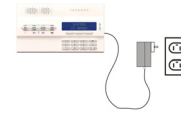

2. Select your language.



3. Select the time format.



4. Set the correct time, then press **ok**.



5. Set the correct date, then press **ok**.



## The Menu Flow

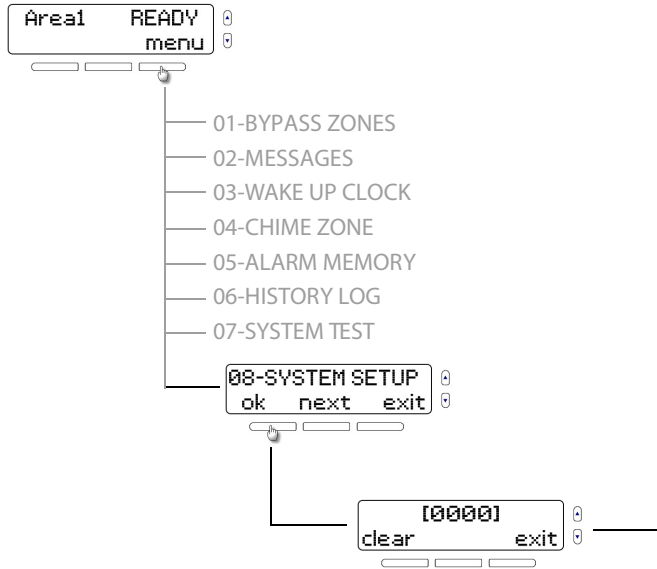

**NOTE:** You can access the System Setup menu by using the arrow keys, or by entering **08**. Once accessed, enter the default installer code (**0000**).

01-ZONES .....	P5
• wireless, voice tag, text name, zone type, areas	
02-AREAS .....	P7
• system/site name, voice tag, area names	
03-OUTPUTS (PGMS) .....	P8
• wireless, voice tag, text name, activation types, event selection	
04-KEYPADS .....	P13
• wireless, voice tag, text name	
05-REPEATERS .....	P15
• wireless, voice tag, text name, select zones/outputs/keypads	
06-SIRENS .....	P17
• wireless, voice tag, text name	
07-DOORBELLS .....	P18
• wireless, voice tag, text name, select tone	
08-DELAYS/TONES .....	P20
• entry delays, exit delay, bell cutoff, bell squawk, pre-alarm	
09-COMMUNICATOR .....	P22
• user call list, SIM cards, account setup	
10-INSTALLER ID .....	P27
• installer/maintenance codes, call-back PC/service tel. #	
11-SYSTEM TEST .....	P29
• signal strength, reporting, zones, remotes, hardware	
12-STAYD PATH .....	P31
• console path, keypad path	
13-VERSION NUMBER .....	P33
• main firmware, chip firmware, serial number, hardware, ECO	
14-ADVANCED PROG (refer to MG6250 Section Programming Guide)	

# 1. Zones

Menu > 08-System Setup > Code > 01-Zones

## Menu Summary

- Add Zones (max. 64)
- Choose Wireless or Hardwired
- Record Voice Tag (max. 3 seconds)
- Enter Zone Name (max. 16 characters)
- Select Zone Type
- Assign to Areas

## Programming Sequence

1. Press **menu**.



2. Select 08-System Setup menu, then press **ok**.

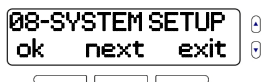

3. Enter your installer code (default: **0000**).



4. Press **ok**.

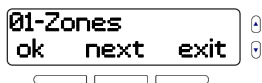

## Add Zones

5. Select a zone to add, then press **ok**.



## Choose Wireless or Hardwired

6. Choose whether the zone is wireless.

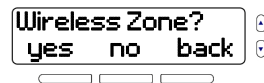

**NOTE:** The MG6250 has two hardwired, on-board input/outputs (I/Os), assignable to either zones or outputs (PGMs). As a result, this screen only appears when you choose zones 1 and 2. Zones 3 to 64 (inclusive) are wireless.

- If **yes**, press **Tamper** or **Learn** on the device (see *a*), or enter its serial number, then press **ok** (see *b*). Once completed, the device's serial number will be registered.

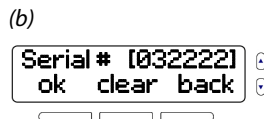

- If **no**, I/O 1 is assigned to zone 1. Press **ok**.

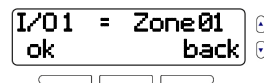

## Record Voice Tag

7. Press **ok**.

Modify Voice Tag	⏪
ok next back	⏩
⏪ ⏩ ⏪	

8. Record tag (max. 3 seconds).

Please Record after the Tone	⏪
⏪ ⏩ ⏪	

9. Play, re-record (**no**), or save (**yes**) tag.

Voice Tag OK?	⏪
play no yes	⏩
⏪ ⏩ ⏪	

**NOTE:** Zone tags will play whenever zone-related actions are taken; for instance, when adding/modifying zones during the programming sequence, arming, disarming, and bypassing zones, or assigning chime zones.

## Enter Zone Name

10. Press **ok**.

Modify Text Name	⏪
ok next back	⏩
⏪ ⏩ ⏪	

11. Enter a name (max. 16 characters), then press **ok**.

Name: Zone 01	⏪
ok clear back	⏩
⏪ ⏩ ⏪	

## Select Zone Type

12. Press **ok**.

Select Zone Type	⏪
ok back	⏩
⏪ ⏩ ⏪	

13. Select the zone type or enter the type's two-digit number (see table 1 on page 7), and then press **ok**.

Delay1	⏪
ok next back	⏩
⏪ ⏩ ⏪	

## Assign to Areas

14. Press **edit**.

Area?	1	⏪
edit next back		⏩
⏪ ⏩ ⏪		

15. Assign zone to areas 1, 2, or both.

Area?	1	⏪
1 2 1&2		⏩
⏪ ⏩ ⏪		

16. Repeat steps 5 to 15 to add other zones (max. 64).

Another Zone?	⏪
no yes	⏩
⏪ ⏩ ⏪	

**Table 1: Zone types and their corresponding numbers**

#	Description	#	Description	#	Description
01	Entry Delay 1	12	Delay fire	23	Follow, no pre-alarm
02	Entry Delay 2	13	Fire silent	24	Instant, no pre-alarm
03	Delay 1, Full arm	14	Delay fire silent	25	Keystwitch maintain
04	Delay 2, Full arm	15	24 hr. buzzer	26	Keystwitch momentary
05	Follow	16	24 hr. burglary	27	Delay 1, Sleep and Full arm
06	Follow, Sleep and Full arm	17	24 hr. holdup	28	Delay 2, Sleep and Full arm
07	Follow, Full arm	18	24 hr. gas	29	Unarmed
08	Instant	19	24 hr. heat	33	Custom 1
09	Instant, Sleep and Full arm	20	24 hr. water	34	Custom 2
10	Instant, Full arm	21	24 hr. freeze	35	Custom 3
11	Fire	22	24 hr. panic	36	Custom 4

**NOTE:** To select a zone type (see *Select Zone Type* on page 6), either scroll the list using the **next** or arrow keys, or enter its corresponding number from table 1 on page 7. For more information on zone types, refer to the MG6250 Section Programming Guide.

## 2. Areas

Menu > 08-System Setup > Code > 02-Areas

### Menu Summary

- Modify System/Site
- Enter System/Site Name (max. 16 characters)
- Record Voice Tag (max. 3 seconds)
- Modify Areas 1 and 2

### Programming Sequence

1. Press **menu**.



2. Select 08-System Setup menu, then press **ok**.



3. Enter your installer code (default: **0000**).



4. Select 02-Areas sub-menu, then press **ok**.



## Modify System/Site

5. Press **ok**.

System/Site Name  
ok next exit

## Record Voice Tag

6. Press **ok**.

Modify Voice Tag  
ok next back

7. Record tag (max. 3 seconds).

Please Record  
after the Tone

8. Play, re-record (**no**), or save (**yes**) tag.

Voice Tag OK?  
play no yes

## Enter System/Site Name

9. Press **ok**.

Modify Text Name  
ok next back

10. Enter a name (max. 16 characters), then press **ok**.

Name: MGG250  
ok clear back

## Modify Areas 1 and 2

11. Repeat steps 5 to 10 for areas 1 and 2.

Area 1 Name  
ok next exit

## 3. Outputs (PGMs)

Menu > 08-System Setup > Code > 03-Outputs

### Menu Summary

- Add Output (max. 8)
- Choose Wireless or Hardwired
- Record Voice Tag (max. 3 seconds)
- Enter Output Name (max. 16 characters)
- Set-up Activation Types
- Set-up Remote Access
- Configure PGM Activation/Deactivation Events
- Set-up Alarm Activation Options
- Custom Setup of PGMs

### Programming Sequence

1. Press **menu**.

13:11  
▶ menu

2. Select 08-System Setup menu, then press **ok**.

08-SYSTEM SETUP  
ok next exit

3. Enter your installer code (default: **0000**).

[0000]  
clear exit



- Select 03-Outputs sub-menu, then press **ok**.



### Add Output

- Select an output to add, then press **ok**.



### Choose Wireless or Hardwired

- Choose whether the output is wireless.



**NOTE:** The MG6250 has two hardwired, on-board input/outputs (I/Os), assignable to either zones or outputs (PGMs). As a result, the screen in step 6 only appears when you choose outputs 1 and 2. Outputs 3 to 8 (inclusive) are wireless.

- If **yes**, press **Tamper** or **Learn** on the device (see *a*), or enter its serial number, then press **ok** (see *b*). Once completed, the device's serial number will be registered.

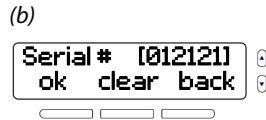

- If **no**, one of the following appears. Press **ok**.

**NOTE:** Screen *a* appears if zones 1 and/or 2 are already assigned to I/O 1 and I/O 2, respectively. Press **ok** and follow instructions on-screen to either keep the I/O assigned to a zone, or delete its zone assignment. Once deleted, you'll be able to assign the on-board I/O to an output. Screen *b* appears if zones 1 and/or 2 are not assigned to the console's two hardwired, on-board I/Os. Press **ok** and follow instructions on-screen.

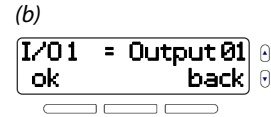

### Record Voice Tag

- Press **ok**.



- Record tag (max. 3 seconds).



- Play, re-record (**no**), or save (**yes**) tag.



## Enter Output Name

10. Press **ok**.

```
Modify Text Name
ok  next  back
  |  |  |
  |  |  |
```

11. Enter a name (max. 16 characters), then press **ok**.

```
Name: Output 01
ok  clear  back
  |  |  |
  |  |  |
```

## Set-up Activation Types

This menu allows you to do the following:

- Set-up remote access (see *Set-up Remote Access*)
  - Configure PGM activation and deactivation events (see page 11)
    - Set-up alarm activation options (see page 11)
- Refer to their respective sections for specific setup instructions.

```
Activation Type
ok                back
  |  |  |
  |  |  |
```

## Set-up Remote Access

1. Press **ok**.

```
Activation Type
ok                back
  |  |  |
  |  |  |
```

2. Press **ok**.

```
Remote Access?
ok  next  back
  |  |  |
  |  |  |
```

**NOTE:** If no remotes are programmed, *No Remote Prog.* appears on-screen. Remotes can be programmed using either the menu (via the master code) or section-based programming methods. To program remotes using the section-based method, refer to the following sections in the MG6250 Section Programming Guide:

- **[0401]** to **[0416]**: Remote control serial number
- **[0440]** to **[0458]**: Programming remote controls
- **[0481]** to **[0496]**: REM3 options
- **[0521]** to **[0536]**: Remote control user labels

3. Choose whether to assign a button.

```
Modify Button?
yes no  back
  |  |  |
  |  |  |
```

• If **yes**, press any button on your remote.

```
Press Any Button
                back
  |  |  |
  |  |  |
```

• If **no**, press **ok** to toggle the output ON/OFF, or press **next** to choose one of the following options:

```
Toggle ON/OFF?
ok  next  back
  |  |  |
  |  |  |
```

- ON for 1 sec.
- ON for 5 sec.
- ON for 15 sec.

- ON for 30 sec.
- ON for 1 min.
- ON for 5 min.
- ON for 15 min.
- ON for 30 min.

4. If desired, add other outputs (max.8).

```

Another Output? 0
yes  no  back 0
  
```

\_ \_ \_

### Configure PGM Activation/ Deactivation Events

1. Press **ok**.

```

Activation Type 0
ok              back 0
  
```

\_ \_ \_

2. Press **next**, select one of the following, and then press **ok**:

```

Remote Access? 0
ok  next  back 0
  
```

\_ \_ \_

- Follow Bell
- Alarm Activation (see *Set-up Alarm Activation Options*)
- Zone Activation
- Follow Full Arm
- Follow Sleep Arm
- Follow Stay Arm
- Console Supervision

- Custom Setup (see *Custom Setup of PGMs* on page 12)

3. Press **edit**.

```

Area? 1 0
edit next back 0
  
```

\_ \_ \_

4. Assign to areas 1, 2, or both.

```

Area? 1 0
1 2 1&2 0
  
```

\_ \_ \_

5. Choose whether to set-up remote access.

```

Remote Access? 0
no  yes 0
  
```

\_ \_ \_

- If **yes**, go to *Set-up Remote Access* on page 10.
- If **no**, choose whether to add another output (see *Add Output* on page 9).

### Set-up Alarm Activation Options

1. Press **ok**.

```

Activation Type 0
ok              back 0
  
```

\_ \_ \_

2. Press **next**.

```

Remote Access? 0
ok  next  back 0
  
```

\_ \_ \_

3. Select Alarm Activation, then press **ok**.

```

Alarm Activation 0
ok  next  back 0
  
```

\_ \_ \_

- Press one of the following:
  - edit:** press to assign the alarm activation to areas 1, 2, or both.
  - next:** press, select one of the following, and then press **ok**:



- Steady on alarm
- Pulse on alarm
- ON for 1 sec.
- ON for 5 sec.
- ON for 15 sec.
- ON for 30 sec.
- ON for 1 min.
- ON for 5 min.
- ON for 15 min.
- ON for 30 min.

- Once complete, choose whether to set-up remote access (see *Set-up Remote Access* on page 10).

### Custom Setup of PGMs

- Press **ok**.



- Press **next**.



- Select Custom Setup, then press **ok**.



- Using the keypad, enter the following for output 1:



- Event number
- Sub-event number
- Partition number

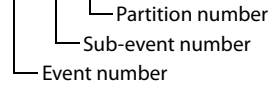

Refer to the MG6250 Section Programming Guide for the complete list of MG6250 events and sub-events.

**NOTE:** For sections [0321] to [0328], the first set of 0s (00-00-0) correspond to activation events; the second set, to deactivation events. Press # at any time to quickly access the next programmable section. In addition, press and hold 0 for three seconds to exit any menu, at any time.

- Enter the PGM options for output 1.



6. Enter the PGM delay for output 1.



7. If desired, add another output.

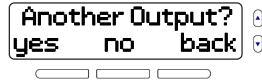

**NOTE:** Outputs (PGMs) 1 to 8 correspond to the following programming sections:

- **[0321] to [0328]:** PGM activation/deactivation events
- **[0341] to [0348]:** PGM options
- **[0361] to [0368]:** PGM delays

For more information on PGM programming, refer to the MG6250 Section Programming Guide.

## 4. Keypads

Menu > 08-System Setup > Code > 04-Keypads

### Menu Summary

- Add Keypad (max. 4)
- Record Voice Tag (max. 3 seconds)
- Enter Keypad Name (max. 16 characters)
- Compatible Keypads (K32RF, K37)

## Programming Sequence

1. Press **menu**.



2. Select 08-System Setup menu, then press **ok**.



3. Enter your installer code (default: **0000**).



4. Select 04-Keypads sub-menu, then press **ok**.



### Add Keypad

5. Select a keypad to add, then press **ok**.



6. Press and hold **PG1** and **BYP** on keypad (see *a*), or enter its serial number, then press **ok** (see *b*). Once completed, the keypad's serial number will be registered.

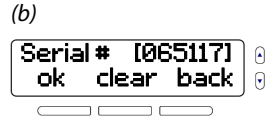

### Record Voice Tag

7. Press **ok**.
8. Record tag (max. 3 seconds).
9. Play, re-record (**no**), or save (**yes**) tag.



### Enter Keypad Name

10. Press **ok**.
11. Enter a name (max. 16 characters), then press **ok**.

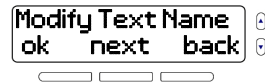

12. Repeat steps 5 to 11 to add other keypads (max. 4).



## Compatible Keypads

### K32RF 32-Zone, Wireless LED Keypad

The K32RF is compatible with the MG6250. For detailed information on the K32RF, visit us at [paradox.com>Magellan](http://paradox.com>Magellan).



### K37 32-Zone, Wireless, Fixed LCD Keypad

The K37 is also compatible with the MG6250. For detailed information on the K37, visit us at [paradox.com>Magellan](http://paradox.com>Magellan).



## 5. Repeaters

Menu > 08-System Setup > Code > 05-Repeaters

### Menu Summary

- Add Repeater (max. 4)
- Record Voice Tag (max. 3 seconds)
- Enter Repeater Name (max. 16 characters)
- Select Zones
- Select Outputs
- Select Keypads
- Compatible Receivers (RPT1)

### Programming Sequence

1. Press **menu**.



2. Select 08-System Setup menu, then press **ok**.

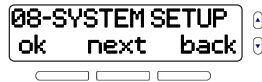

3. Enter your installer code (default: **0000**).



4. Select 05-Repeaters sub-menu, then press **ok**.



### Add Repeater

5. Select a repeater to add, then press **ok**.



6. Press **Learn** button on repeater (see *a*), or enter its serial number, then press **ok** (see *b*). Once completed, the repeater's serial number will be registered.

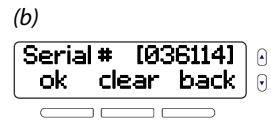
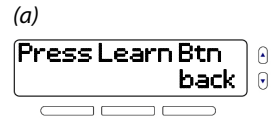

### Record Voice Tag

7. Press **ok**.



8. Record tag (max. 3 seconds).



9. Play, re-record (**no**), or save (**yes**) tag.



## Enter Repeater Name

10. Press **ok**.



11. Enter a name (max. 16 characters), then press **ok**.



## Select Zones

12. Press **ok**.



13. Press **yes** to select all zones, or **no** to select individual zones (1 to 64).



**NOTE:** If no zones are programmed, *No Zone Prog.* will appear on-screen.

## Select Outputs

14. Press **ok**.



15. Press **yes** to select all outputs, or **no** to select individual outputs (1 to 8).



**NOTE:** If no outputs are programmed, *No Output Prog.* will appear on-screen.

## Select Keypads

16. Press **ok**.



17. Press **yes** to select all keypads, or **no** to select individual keypads (1 to 4).



**NOTE:** If no keypads are programmed, *No Keypad Prog.* will appear on-screen.

18. Press **ok** to save the profile, or **next** to reselect zones, outputs, and keypads.





19. Repeat steps 5 to 18 to add other repeaters (max. 4).



## Compatible Receivers

### RPT1 Magellan Wireless Repeater Module

The RPT1 is compatible with the MG6250. For detailed information on the RPT1, visit us at [paradox.com](http://paradox.com)>Magellan>Wireless Accessories.

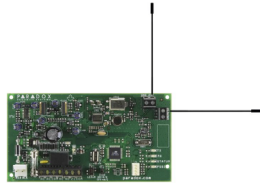

## 6. Sirens

Menu > 08-System Setup > Code > 06-Sirens

### Menu Summary

- Add Siren (max. 4)
- Record Voice Tag (max. 3 seconds)
- Enter Siren Name (max. 16 characters)
- Compatible Sirens (SR150)

## Programming Sequence

1. Press **menu**.



2. Select 08-System Setup menu, then press **ok**.



3. Enter your installer code (default: **0000**).



4. Select 06-Sirens sub-menu, then press **ok**.



### Add Siren

5. Select a siren to add, then press **ok**.



6. Press **Learn** button on siren (see *a*), or enter its serial number, then press **ok** (see *b*). Once completed, the siren's serial number will be registered.

(a)

Press Learn Btn  
back

(b)

Serial# [036251]  
ok clear back

### Record Voice Tag

7. Press **ok**.
8. Record tag (max. 3 seconds).
9. Play, re-record (**no**), or save (**yes**) tag.

Modify Voice Tag  
ok next back

Please Record  
after the Tone

Voice Tag OK?  
play no yes

### Enter Siren Name

10. Press **ok**.
11. Enter a name (max. 16 characters), then press **ok**.

Modify Text Name  
ok next back

Name: Siren01  
ok clear back

12. Repeat steps 5 to 11 to add other sirens (max. 4).

Another Siren?  
yes no back

## Compatible Sirens

### SR150 Wireless Siren with Built-in Strobe Light

The SR150 is compatible with the MG6250. For detailed information on the SR150, visit us at [paradox.com>Magellan>Wireless Siren](http://paradox.com>Magellan>Wireless Siren).



## 7. Doorbells

Menu > 08-System Setup > Code > 07-Doorbells

### Menu Summary

- Add Doorbell (max. 2)
- Record Voice Tag (max. 3 seconds)
- Enter Doorbell Name (max. 16 characters)
- Select Tone

## Programming Sequence

1. Press **menu**.



2. Select 08-System Setup menu, then press **ok**.



3. Enter your installer code (default: **0000**).



4. Select 07-Doorbells sub-menu, then press **ok**.



### Add Doorbell

5. Select a doorbell to add, then press **ok**.



6. Press **Tamper** or **Learn** on the device, or enter its serial number, then press **ok** (see *b*). Once completed, the doorbell's serial number will be registered.

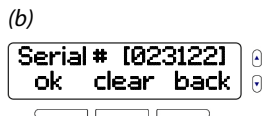

**NOTE:** The MG6250 only supports wireless doorbells.

### Record Voice Tag

7. Press **ok**.



8. Record tag (max. 3 seconds).



9. Play, re-record (**no**), or save (**yes**) tag.



### Enter Doorbell Name

10. Press **ok**.

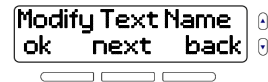

11. Enter a name (max. 16 characters), then press **ok**.



### Select Tone

12. Select one of four available tones, then press **ok**.



- Repeat steps 5 to 12 to add another doorbell (max. 2).



## 8. Delays/Tones

Menu > 08-System Setup > Code > 08-Delays/Tones

### Menu Summary

- Set-up Entry Delays (000 to 255 sec.)
- Set-up Exit Delay (000 to 255 sec.)
- Set-up Bell Cutoff Delay (000 to 255 min.)
- Set-up Bell Squawk (ON or OFF)
- Set-up Pre-Alarm Delay (000 to 255 sec.)

### Programming Sequence

- Press **menu**.



- Select 08-System Setup menu, then press **ok**.

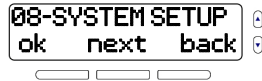

- Enter your installer code (default: **0000**).



- Select 08-Delays/Tones sub-menu, then press **ok**.



### Set-up Entry Delays

- Press **ok**.



- Enter the delay (000 to 255 sec.), then press **ok**.



**NOTE:** The default delay is 045 sec. If left blank, delay is 000.

- Select one of the following, then press **ok**:



- Tonality 1
- Tonality 2
- Tonality 3
- Tonality 4
- Nothing (no tone)
- Beeping
- Countdown

8. Repeat steps 5 to 7 for Entry Delay 2, if desired. Once complete, press **ok** to access Exit Delay.

Entry Delay 2?
ok next exit
□ □ □

### Set-up Exit Delay

9. Press **ok**.

Exit Delay?
ok next exit
□ □ □

10. Press **ok**.

Area 1
ok next back
□ □ □

11. Enter the delay (000 to 255 sec.), then press **ok**.

Delay: [060] sec
ok clear back
□ □ □

**NOTE:** The default delay is 060 sec. If left blank, delay is 000.

12. Select one of the following, then press **ok**:

Tone: Tonality 1
ok next back
□ □ □

- Tonality 1
- Tonality 2
- Tonality 3
- Tonality 4
- Nothing (no tone)

- Beeping
- Countdown

13. Repeat steps 10 to 12 for area 2, if desired. Once complete, press **ok** to access Bell Cutoff Delay.

Area 2
ok next back
□ □ □

**NOTE:** The default delay is 015 sec. If left blank, delay is 000.

### Set-up Bell Cutoff Delay

14. Press **ok**.

Bell Cutoff Del?
ok next exit
□ □ □

15. Press **ok**.

Area 1
ok next back
□ □ □

16. Enter the delay (000 to 255 min.), then press **ok**.

Delay: [004] min
ok clear back
□ □ □

**NOTE:** The default delay is 004 min. If left blank, delay is 000.

17. Repeat steps 15 and 16 for area 2, if desired. Once complete, press **ok** to access Bell Squawk.

Area 2
ok next back
□ □ □

## Set-up Bell Squawk

18. Press **ok**.



19. Choose whether to turn the bell squawk **on** or **off** (default is **off**).



## Set-up Pre-Alarm Delay

20. Press **ok**.



21. Enter the delay (000 to 255 sec.), then press **ok**.



## 9. Communicator

Menu > 08-System Setup > Code > 09-Communicator

### Menu Summary

- Set-up User Call List (max. 8 phone numbers)
- Set-up SIM Cards (max. 2)
- Account Setup: Areas
- Account Setup: GSM/Land Tel #
- Account Setup: GPRS
- Set-up GPRS Receivers

## Programming Sequence

1. Press **menu**.



2. Select 08-System Setup menu, then press **ok**.



3. Enter your installer code (default: **0000**).



4. Select 09-Communicator sub-menu, then press **ok**.



### Set-up User Call List

5. Press **ok**.



6. Press **ok**.



7. Enter a telephone number, then press **ok**.



**NOTE:** Pressing **pause** inserts a four-second pause, before the subsequent numbers are dialed.

8. Choose whether you'd like the console to place a voice call when reporting system events, then press **next**.

Voice Call?	yes	Ⓜ
no	next	back
Ⓜ	Ⓜ	Ⓜ

9. If a GPRS module is connected, choose whether you'd like the console to send an SMS text message when reporting system events, then press **next**. This screen appears only if a GPRS module is connected.

Send SMS?	yes	Ⓜ
no	next	back
Ⓜ	Ⓜ	Ⓜ

**NOTE:** If **no** is chosen in step 8, and a GPRS module is not connected (or **no** chosen in step 9, if one is connected), you will be redirected to step 6 (adding additional telephone numbers).

10. Press **edit** to select the area from which alarm notifications will be sent, then press **next**.

Select Area?	1&2	Ⓜ
edit	next	back
Ⓜ	Ⓜ	Ⓜ

**NOTE:** The Select Area screen only appears in a partitioned system.

11. Press **edit**.

Zone Alarm?	yes	Ⓜ
edit	next	back
Ⓜ	Ⓜ	Ⓜ

12. Choose whether to report zone alarms, then press **next**. If **yes**, go to step 13; if **no**, go to step 14.

Zone Alarm?	yes	Ⓜ
no	next	back
Ⓜ	Ⓜ	Ⓜ

**NOTE:** If no zones are programmed in the selected area, *No Zone on Area #* will appear on-screen.

13. Press **yes** to report zone alarms from all zones, or **no** to select individual zones (1 to 64).

All Zones?	yes	Ⓜ
yes	no	back
Ⓜ	Ⓜ	Ⓜ

14. Press **edit**.

Panics?	yes	Ⓜ
edit	next	back
Ⓜ	Ⓜ	Ⓜ

15. Choose whether to report panics, then press **next**.

Panics?	yes	Ⓜ
no	next	back
Ⓜ	Ⓜ	Ⓜ

16. Press **edit**.

Disarming?	yes	Ⓜ
edit	next	back
Ⓜ	Ⓜ	Ⓜ

17. Choose whether to report when a user disarms the area selected in step 10, then press **next**. If **yes**, go to step 18; if **no**, go to step 19.

```
Disarming?  yes  ⏪
            no  next  back  ⏩
            ┌──┬──┬──┐
```

**NOTE:** If no users are programmed in the selected area, *No User on Area #* will appear on-screen.

18. Press **yes** to report area disarming from all users, or **no** to select individual users (1 to 32).

```
All Users?  ⏪
            yes  no  back  ⏩
            ┌──┬──┬──┐
```

19. Press **edit**.

```
Trouble?    yes  ⏪
            edit next  back  ⏩
            ┌──┬──┬──┐
```

20. Choose whether to report troubles, then press **next**. If **yes**, go to step 21; if **no**, go to End of List.

```
Trouble?    yes  ⏪
            no  next  back  ⏩
            ┌──┬──┬──┐
```

21. Press **yes** to report all troubles, or **no** to select the following troubles individually:

```
All Trouble?  ⏪
              yes  no  back  ⏩
              ┌──┬──┬──┐
```

- AC trouble

- Battery trouble

22. Repeat steps 6 to 21 to add other telephone numbers (max. 8).

```
Another Tel #?  ⏪
                yes  no  back  ⏩
                ┌──┬──┬──┐
```

### Set-up SIM Cards

23. Press **ok**.

```
SIM Card # 1  ⏪
              ok  next  back  ⏩
              ┌──┬──┬──┐
```

24. Press **ok**.

```
Provider Name  ⏪
              ok  next  back  ⏩
              ┌──┬──┬──┐
```

25. Enter the SIM card provider's name (max. 32 characters), then press **ok**.

```
Name: XXXXXXX  ⏪
              ok  next  back  ⏩
              ┌──┬──┬──┐
```

26. Press **view**.

```
SIM Tel #     ⏪
              view next  back  ⏩
              ┌──┬──┬──┐
```

27. The telephone number provided by SIM card is read-only. Press **ok**.

```
Tel#: 5555555555  ⏪
              ok      back  ⏩
              ┌──┬──┬──┐
```



28. Press **ok**.



APN Settings  
ok next back

A screenshot of a menu titled "APN Settings". The menu has three options: "ok", "next", and "back". Below the menu are three horizontal lines representing the physical buttons on the device.

29. Enter the APN (Access Point Name; max. 32 characters), then press **ok**.

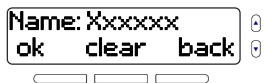

Name: XXXXXXXX  
ok clear back

A screenshot of a screen for entering the APN name. The text "Name: XXXXXXXX" is displayed. Below it are three options: "ok", "clear", and "back".

30. Enter an APN user name (max. 32 characters), then press **ok**.

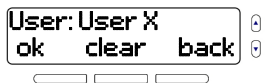

User: User X  
ok clear back

A screenshot of a screen for entering the APN user name. The text "User: User X" is displayed. Below it are three options: "ok", "clear", and "back".

31. Enter a user-specific APN password (max. 32 characters), then press **ok**.

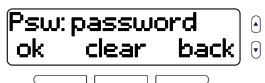

Psw: password  
ok clear back

A screenshot of a screen for entering the APN password. The text "Psw: password" is displayed. Below it are three options: "ok", "clear", and "back".

32. Press **view**.



IP Address  
view next back

A screenshot of a menu titled "IP Address". The menu has three options: "view", "next", and "back". Below the menu are three horizontal lines representing the physical buttons on the device.

33. The IP address provided by SIM card is read-only. Press **ok**.



000.000.000.000  
ok back

A screenshot of a screen showing the IP address "000.000.000.000". Below it are two options: "ok" and "back".

34. Press **ok**.



IP Port  
ok clear back

A screenshot of a menu titled "IP Port". The menu has three options: "ok", "clear", and "back". Below the menu are three horizontal lines representing the physical buttons on the device.

35. Enter the console's IP port number, then press **ok**.

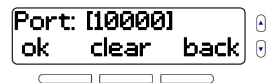

Port: [10000]  
ok clear back

A screenshot of a screen for entering the IP port number. The text "Port: [10000]" is displayed. Below it are three options: "ok", "clear", and "back".

36. Press **exit** to quit, or **next** to go to SIM Card # 2.



End of List  
next exit

A screenshot of a menu titled "End of List". The menu has two options: "next" and "exit". Below the menu are three horizontal lines representing the physical buttons on the device.

37. Repeat steps 23 to 36 for SIM card 2.



SIM Card # 2  
ok next back

A screenshot of a menu titled "SIM Card # 2". The menu has three options: "ok", "next", and "back". Below the menu are three horizontal lines representing the physical buttons on the device.

### Account Setup: Areas

38. Press **ok**.



Account Setup  
ok next back

A screenshot of a menu titled "Account Setup". The menu has three options: "ok", "next", and "back". Below the menu are three horizontal lines representing the physical buttons on the device.

39. Press **ok**.



Account #  
ok next back

A screenshot of a menu titled "Account #". The menu has three options: "ok", "next", and "back". Below the menu are three horizontal lines representing the physical buttons on the device.

40. Enter a four-digit personal identification number for area 1, then press **ok**.

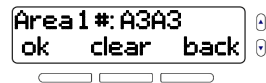

Area 1 #: A3A3  
ok clear back

A screenshot of a screen for entering the personal identification number for area 1. The text "Area 1 #: A3A3" is displayed. Below it are three options: "ok", "clear", and "back".

41. Repeat step 40 for area 2.

## Account Setup: GSM/Land Tel #

42. Press **ok**.



GSM/Land Tel #  
ok next back

Three navigation buttons (left, center, right) are located below the screen.

43. Select **LAND** or **GSM** as the primary communication channel, then press **next**.



Primary: LAND  
GSM next back

Three navigation buttons (left, center, right) are located below the screen.

**NOTE:** The screen in step 43 only appears if a GPRS module is detected. In addition, remote access is applicable only to the primary communication channel.

44. Enter your GSM or landline phone number.



Tel#1: 555555555  
ok pause back

Three navigation buttons (left, center, right) are located below the screen.

**NOTE:** Pressing **pause** inserts a four-second pause, before the subsequent numbers are dialed.

45. If desired, add a secondary telephone number, then press **ok**.

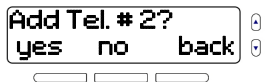

Add Tel. # 2?  
yes no back

Three navigation buttons (left, center, right) are located below the screen.

## Account Setup: GPRS

46. Press **ok**.



GPRS Setting  
ok next back

Three navigation buttons (left, center, right) are located below the screen.

47. Press **ok**.



GPRS Profile  
ok next back

Three navigation buttons (left, center, right) are located below the screen.

48. Enter a two-digit GPRS profile number, then press **ok**.

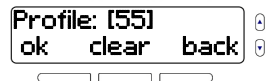

Profile: [55]  
ok clear back

Three navigation buttons (left, center, right) are located below the screen.

## Set-up GPRS Receivers

49. Press **ok**.

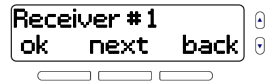

Receiver # 1  
ok next back

Three navigation buttons (left, center, right) are located below the screen.

50. Press **ok**.



WAN1 Address  
ok next back

Three navigation buttons (left, center, right) are located below the screen.

51. Enter your WAN (Wide Area Network) 1 IP address, then press **ok**.

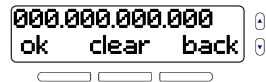

000.000.000.000  
ok clear back

Three navigation buttons (left, center, right) are located below the screen.

52. Enter your receiver's IP port number, then press **ok**.

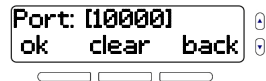

Port: [10000]  
ok clear back

Three navigation buttons (left, center, right) are located below the screen.

53. Repeat steps 50 to 52 for WAN 2.



WAN 2 Address  
ok next back

Three navigation buttons (left, center, right) are shown below the menu.

54. Press **ok**.



GPRS Password  
ok next back

Three navigation buttons (left, center, right) are shown below the menu.

55. Enter a personal, six-digit GPRS password, then press **ok**.



Psw: 123456  
ok clear back

Three navigation buttons (left, center, right) are shown below the menu.

56. Press **ok**. During the GPRS registration process, the IP address and port status will appear on-screen.



View Status  
ok next back

Three navigation buttons (left, center, right) are shown below the menu.

57. Press **ok**.



Registration OK  
ok

Three navigation buttons (left, center, right) are shown below the screen.

58. Repeat steps 49 to 57 for receiver 2, if applicable.



Receiver # 2  
ok next back

Three navigation buttons (left, center, right) are shown below the menu.

## 10. Installer ID

Menu > 08-System Setup > Code > 10-Installer ID

### Menu Summary

- Modify Installer Code (must be 4 digits)
- Set-up CallBack PC Telephone Number (max. 32 digits)
- Modify Maintenance Code (must be 4 digits)
- Set-up Service Telephone Number (max. 32 digits)

### Difference between Installer and Maintenance Codes

The installer code (default: **0000**) grants access to all of the console's programmable features and options. The maintenance code (no default) also grants access to all of the console's programmable features and options, except for its communication settings and Installer ID section. In addition, the maintenance code can be modified using the installer code, however, the installer code cannot be modified using the maintenance code. Both the installer and maintenance codes can be four or six digits long, where each digit is a value from 0 to 9 (inclusive).

**NOTE:** To modify the length of the installer or maintenance codes, refer to the MG6250 Section Programming Guide. By default, these codes are four digits in length.

## Programming Sequence

1. Press **menu**.



2. Select 08-System Setup menu, then press **ok**.



3. Enter your installer code (default: **0000**).



4. Select 10-Installer ID sub-menu, then press **ok**.



### Modify Installer Code

5. Press **ok**.

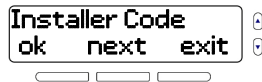

6. Enter desired installer code (4 digits), then press **ok**.

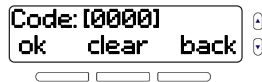

**NOTE:** The default installer code is **0000**.

7. Enter the user's name (max. 16 characters), then press **ok**.



8. Enter a user-specific password (max. 16 characters), then press **ok**.



### Modify Maintenance Code

9. Press **ok**.



10. Enter desired maintenance code (4 digits), then press **ok**.

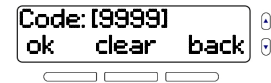

11. Enter the user's name (max. 16 characters), then press **ok**.



12. Enter a user-specific password (max. 16 characters), then press **ok**.

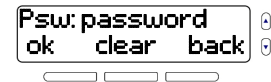

### Set-up CallBack PC Telephone Number

13. Press **ok**.



14. Enter desired telephone number (max. 32 digits), then press **ok**. Pressing **pause** inserts a four-second pause, before the subsequent numbers are dialed.



**NOTE:** When upgrading its firmware, the MG6250 uses the PC telephone number to communicate directly with the PC from which the firmware will be upgraded.

### Set-up Service Telephone Number

15. Press **ok**.



16. Enter desired telephone number (max. 32 digits), then press **ok**. Pressing **pause** inserts a four-second pause, before the subsequent numbers are dialed.



**NOTE:** The MG6250 communicates directly with installers or maintenance personnel via the service telephone number. This feature provides technical support to the user when needed.

## 11. System Test

Menu > 08-System Setup > Code > 11-System Test

### Menu Summary

- Test Signal Strength
- Test Reporting
- Test Zones
- Test Remotes
- Test Hardware

### Programming Sequence

1. Press **menu**.



2. Select 08-System Setup menu, then press **ok**.



3. Enter your installer code (default: **0000**).



4. Select 11-System Test sub-menu, then press **ok**.



### Test Signal Strength

The signal strength indicators outlined in table 2 apply to zones, outputs, keypads, repeaters, and sirens.

**Table 2: Signal strength indicator for wireless transmitters**

Signal Strength	Result
8 to 10	Strong signal
5 to 7	Average signal
1 to 4	Weak signal (relocate)

**NOTE:** For each programmed wireless device, the signal strength (represented by a numerical value) and resulting description, will be displayed on-screen.

5. Press **ok**.



6. Press **next**.



7. Keep pressing **next** to view and hear the signal strengths of your wireless



transmitters for all zones, outputs, keypads, repeaters, and sirens.

**NOTE:** Signal strength will only appear for devices with wireless transmitters. For instance, if zones 1 and/or 2 are assigned as hardwired zones, their signal strengths will not appear. In addition, if no wireless zone is assigned, *No Zone Prog.* will appear on-screen – the same applies to outputs, keypads, repeaters, and sirens. Refer to their respective sections in this manual for details on how to program these devices.

### Test Reporting

8. Press **ok**.



9. Wait for the GPRS test results, or press **cancel** to quit.



10. Once complete, the GPRS test result will appear. The console will then perform a landline test, followed by a GSM test.



11. After all tests are complete, press **finish**.



### Test Zones

12. Press **ok**.



13. Trigger devices on all zones. The status of each zone will appear on-screen and its name will sound once activated. Press **finish** once all zones are tested.



**NOTE:** If no zones are programmed, *No Zone Prog.* will appear on-screen.

### Test Remotes

14. Press **ok**.



15. Press any button on each of your programmed remotes. The status of each remote will appear on-screen.



**NOTE:** If no remotes are programmed, *No Remote Prog.* will appear on-screen.

### Test Hardware

16. Press **ok**.

The console will check the status of its LEDs, speaker, siren, AC power, and battery and provide the results once complete. Follow instructions on-screen to repair the issues found with any of these components.



17. Press **ok**.



18. Press **next** to scroll through the list of transmitters, and **ok** to view their status.







## 12. StayD Path

Menu > 08-System Setup > Code > 12-StayD Path



### Menu Summary



- Add Console Path
- Add Keypad Paths (max. 4)

## Programming Sequence



1. Press **menu**.  

2. Select 08-System Setup menu, then press **ok**.  

3. Enter your installer code (default: **0000**).  

4. Select 12-StayD Path sub-menu, then press **ok**.  

### Add Console Path

5. Press **ok**.  

6. Press **ok**.  

7. Select a zone as an entry point, then press **ok**.  

8. Press **ok** to add a second point.  

9. Select a zone as a second point, then press **ok**.  

10. Repeat steps 8 and 9 if you choose to add points 3 and 4, then return to StayD Path's initial screen (see step 4).  

### Add Keypad Paths

11. Press **ok**.  

12. Select Add Keypad1 Path, then press **ok**.  

13. Press **ok**.  



14. Select a zone as an entry point, then press **ok**.



**NOTE:** A zone can only be an entry point for one type of path – console or keypad. For instance, if zone 1 was added as an entry point for your console path, it cannot be assigned as an entry point for any of your subsequent keypad paths; it can, however, be assigned as a point in your path.

15. Press **ok** to add a second point.



16. Select a zone as a second point, then press **ok**.



17. Repeat steps 15 and 16 if you choose to add points 3 and 4, then return to the StayD Path's initial screen (see step 11).



18. Repeat steps 11 to 17 if you wish to add additional keypad paths (max. 4).

**NOTE:** For StayD paths (console and keypad paths), only four points (or zones) can be assigned, i.e., an entry point and three other points in each respective path. If there are no zones available for points you wish to assign, *No Zone Available* will appear on-screen (see *Add Zones* on page 5 for details on adding zones). In addition, assigned points can be modified and paths deleted, in the StayD Path menu.

### 13. Version Number

Menu > 08-System Setup > Code > 13-Version Num.

#### Menu Summary

- Main Firmware Version (FW)
- Hardware Version (HW)
- RF Chip Firmware Version (RF)
- Engineering Change Order (ECO)
- Control Panel Serial Number (S/N)

#### Programming Sequence

1. Press **menu**.



2. Select 08-System Setup menu, then press **ok**.

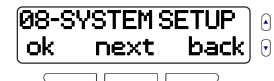

3. Enter your installer code (default: **0000**).



4. Select 13-Version Num. sub-menu, then press **ok**.



### Main Firmware Version (FW)

5. FW indicates the main firmware version. Press **next**.



### RF Chip Firmware Version (RF)

6. RF indicates the RF chip's firmware version. Press **next**.



### Control Panel Serial Number (S/N)

7. S/N indicates the control panel's serial number. Press **next**.



### Hardware Version (HW)

8. HW indicates the console's hardware version. Press **next**.



### Engineering Change Order (ECO)

9. ECO indicates the console's latest ECO number. Press **next** to go to End of List, or **exit** to quit.



**NOTE:** The various version and serial numbers appearing in steps 5 to 9 may differ from those which appear on the actual product.

## Trouble Display

Table 3 provides a description of the different troubles associated with the MG6250. To view troubles on the console, press **1**. On the wireless keypads compatible with the MG6250 (i.e., K32RF and K37), **TBL** will illuminate to indicate that the console has encountered a trouble. Press **TBL** to view the trouble. Once pressed, the following occurs: on the K37, the trouble's corresponding number will appear on-screen; on the K32RF, the trouble's corresponding number key will illuminate.

**Table 3: Description of trouble messages on the MG6250**

Keypad Key (K32RF/K37)	Trouble Group	Trouble Sub-group
1	Battery trouble	Console low battery
		Console battery disconnected
		Doorbell 1 or 2 low battery
		Any RF module low battery
2	Timer loss	Console time lost (set time and date)
3	Power overload	Console power supply voltage too high
4	Power failure	Console power failure
		Any RF module power failure
5	Supervision lost	Any RF module supervision lost
6	Landline TLM	Console landline telephone line monitoring
7	GSM trouble	GSM missing module
		GSM missing SIM card 1 or 2
		GSM no service (network loss)

**Table 3: Description of trouble messages on the MG6250**

8	IP trouble	IP missing module
		IP no service
		IP receiver 1 or 2 supervision lost
		IP receiver 1 or 2 unregistered
9	Tamper trouble	Console tamper
		Any RF module tamper
10	Communication trouble	Fail to communicate with central
		Fail to communicate with personal phone number
		Fail to communicate with PC
11	RF interference	RF interference

## System Reset

To reset the system to its default factory settings, press and hold the **\*** and **#** buttons during system power-up, or access section **[9000]** when using section-based programming.

## Demo Mode

Demo mode provides a quick preview of the console's visual and audible features. Upon entering demo mode, the console plays a sequence of these features, such as playing its intro and greeting, as well as flashing LEDs and sounding tones and sirens. Demo mode is only accessible via the system master code (default **1234/123456**) and can be accessed as follows:

**Menu > 08-System Setup > Enter Code > 12-Demo Mode.**



Lined writing area with horizontal lines.





# Index

## A

Access Point Name (APN) .....	25
Areas	
entering system/site name .....	8
menu summary .....	7
modifying areas 1 and 2 .....	8
modifying system/site .....	8
recording voice tag .....	8

## C

clock setup .....	3
codes	
installer default .....	27
installer modification .....	28
installer vs. maintenance .....	27
maintenance modification .....	28

## Communicator

GPRS setting in account setup .....	26
GSM/land setting in account setup .....	26
menu summary .....	22
setting-up areas in account setup .....	25
setting-up GPRS receivers .....	26
setting-up SIM cards .....	24
setting-up user call list .....	22

## D

date

setting .....	3
Delays/Tones	
menu summary .....	20
setting-up bell cutoff delay .....	21
setting-up bell squawk .....	22
setting-up entry delays .....	20
setting-up exit delay .....	21
setting-up pre-alarm delay .....	22
demo mode .....	35
Doorbells	
adding doorbells .....	19
entering doorbell name .....	19
menu summary .....	18
recording voice tag .....	19
selecting tonality .....	19

## G

### GPRS

<i>see also</i> Communicator	
test reporting .....	30

### GSM

<i>see also</i> Communicator	
test reporting .....	30

## I

initial power-up .....	3
Installer ID	



difference between installer & maintenance codes .....	27
menu summary .....	27
modifying installer code .....	28
modifying maintenance code .....	28
setting-up callback PC telephone number .....	29
setting-up service telephone number .....	29

## K

K32RF .....	14
K37 .....	14

### Keypads

adding keypads .....	13
entering keypad name .....	14
K32RF 32-Zone, Wireless LED Keypad .....	14
K37 32-Zone, Wireless, Fixed LCD Keypad .....	14
menu summary .....	13
recording voice tag .....	14

## M

### menu

01-Zones .....	5
02-Areas .....	7
03-Outputs .....	8
04-Keypads .....	13
05-Repeaters .....	15
06-Sirens .....	17
07-Doorbells .....	18
08-Delays/Tones .....	20
09-Communicator .....	22
10-Installer ID .....	27

11-System Test .....	29
12-StayD Path .....	31
13-Version Num. ....	33

## MG6250

description .....	3
initial power-up .....	3
menu flow .....	4
on-board inputs/outputs .....	5, 9
Section Programming Guide .....	3, 7, 12, 13

## O

### Outputs

adding outputs .....	9
configuring PGM activation/deactivation events .....	11
custom setup of PGMs .....	12
entering output name .....	10
event number .....	12
menu summary .....	8
programming sections .....	13
recording voice tag .....	9
setting-up activation types .....	10
setting-up alarm activation options .....	11
setting-up remote access .....	10, 11
sub-event number .....	12

## P

PGM *see* Outputs

## R

Repeaters

adding repeaters .....	15
entering repeater name .....	16
menu summary .....	15
recording voice tag .....	15
RPT1 Magellan Wireless Repeater Module .....	17
selecting keypads .....	16
selecting outputs .....	16
selecting zones .....	16
RPT1 .....	17
<b>S</b>	
selecting language .....	3
SIM cards <i>see</i> Communicator	
Sirens	
adding sirens .....	17
entering siren name .....	18
menu summary .....	17
recording voice tag .....	18
SR150 Wireless Siren with Built-in Strobe Light .....	18
SR150 .....	18
StayD Path	
adding console path .....	32
adding keypad paths .....	32
menu summary .....	31
System Test	
menu summary .....	29
testing hardware .....	31
testing remotes .....	31
testing reporting .....	30

testing signal strength .....	30
testing zones .....	31

## T

### time

selecting format .....	3
setting .....	3

## V

### Version Number

control panel serial number (S/N) .....	34
engineering change order (ECO) .....	34
hardware version (HW) .....	34
main firmware version (FW) .....	34
menu summary .....	33
RF chip firmware version (RF) .....	34

## W

Wide Area Network (WAN) .....	26
-------------------------------	----

## Z

### Zones

adding zones .....	5
assigning to areas .....	6
assigning zone type .....	6
entering zone name .....	6
menu summary .....	5
recording voice tag .....	6
wireless or hardwired .....	5





The whole Paradox team wishes you a successful and easy installation. We hope this product performs to your complete satisfaction. Should you have any questions or comments, please contact us.

For support, please contact your local distributor, or dial 1-800-791-1919 (in North America) or +1-450-491-7444 (outside North America), Monday to Friday, from 8:00 a.m. to 8:00 p.m. EST.

You may also e-mail us at [support@paradox.com](mailto:support@paradox.com).

Additional information can be found at [PARADOX.COM](http://PARADOX.COM)

**P** **▲** **R** **▲** **D** **O** **X™**

Printed in Canada - 07/2014

[PARADOX.COM](http://PARADOX.COM)

MG6250-EQ01